

Article number: 03469050  
 Description: Fluro Rod end EA 50D-NIRO  
 Note: 50

## Measures

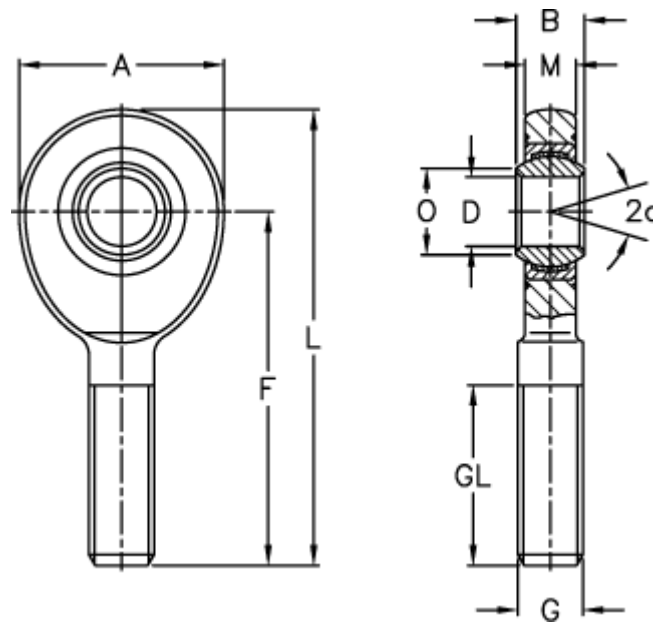

A	= 112	L	= 241
a (degrees)	= 6	M	= 30
B	= 35	O	= 56
D	= 50	Static drive kN	= 216
Dynamic drive (kN)	= 308	Weight	= 3450
F	= 185		
g	= M45x3		
GL	= 107		